

BM300

Operational Manual



TABLE OF CONTENTS

1. INTRODUCTIONS.....	1
1.1 FUNCTION SPECIFICATION.....	1
1.2 FEATURES.....	1
2 THE INSTALLATION, WIRING AND CONFIGURATION.....	2
2.1 DIMENSIONS AND INSTALLATION.....	3
2.2 WIRING AND CONFIGURATION.....	5
3 OPERATING INSTRUCTIONS.....	8
3.1 BUTTON OPERATION.....	9
3.2 DATA READ.....	9
3.3 PARAMETER SETTINGS.....	15
3.4 LOCAL OPERATION.....	20
4 COMMUNICATION.....	22
4.1 MODBUS PROTOCOL OVERVIEW.....	22
4.2 COMMUNICATION PROTOCOL ADDRESS TABLE AND DESCRIPTION.....	22
5 TRANSPORTATION AND STORAGE.....	28
APPENDIX.....	29
A. THE DEFAULT VALUE.....	29
B. TECHNICAL INDICATORS.....	30
C. ORDER INSTRUCTIONS.....	31

1. Introductions

1.1 Function Specification

BM300 three phase intelligent digital display meter is an intelligent device for medium low voltage system (6 ~ 35kV and 0.4kV). It has powerful function of data acquisition and processing, and realizes the measurement and calculation of basic single loop AC parameters, and the accumulation function of electric energy. BM300 provides a communication interface, supports the MODBUS communication protocol of the RS485 interface, and connects to the computer monitoring system. The configuration of the device is shown in figure 1-1-1.



Fig 1.1.1 The appearance of BM300

1.2 Features

1.2.1 BM300 has powerful data acquisition and processing functions

- Support three phase three wire and three phase four wire system with optional function, There are three phase voltage, three phase current, total active, total reactive power, the active and reactive power of each phase, power factor, power factor of each phase, system frequency, total active electrical degree, total apparent electrical degree, the measurement and calculation function of active electrical degree and apparent electrical degree of each phase .
- It can check all kinds of electrical parameters, running state, etc. of a circuit, and can view or set running parameters.

1.2.2 High safety and reliability

BM300 can run steadily in the complex power system.

- Electrostatic discharge immunity test : level 3
- Electrical fast transients immunity test : level 3
- Surge immunity test : level 3
- Power frequency magnetic field immunity test : level 3
- Oscillation wave immunity test : level 3
- The IP level of panel: IP50, the IP level of shell: IP20

1.2.3 Small size, easy installation

BM300 dimensions conform DIN96 × 96 standard, the shell depth of 60mm, using a self-locking panel mounting mechanism, without screws to install. Small form factor and simple installation makes BM300 disassembly very convenient.

1.2.4 System wiring convenient and flexible

System wiring three phase four wire system 3CT (3P4W / 3PT + 3CT), three phase four wire system 1CT (3P4W / 3PT + 1CT), three phase three wire system 3CT (3P3W / 3PT + 3 CT), three phase three wire system 2CT 3P3W / 3PT + 2CT), three phase three wire 1CT (3P3W / 3PT + 1CT).

1.2.5 Intuitive, display,easy to operate

High-brightness LED display can display a number of real-time information, ,the operator can grasp in a short time, reading data and parameter settings and other operations is simple and easy.

1.2.6 Application areas of BM300

Medium and low voltage distribution automation, intelligent switch cabinet, system of load control, industrial automation, building automation, energy management systems.

2 The installation, wiring and configuration

This chapter details the installation method, wiring and configuration of the BM300. Please read carefully before installation.

2.1 Dimensions and installation

2.1.1 Dimensions of mechanical devices

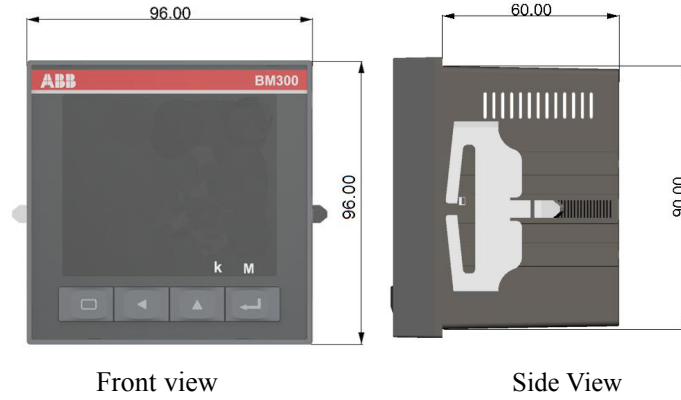

Fig 2.1.1.1. Device size figure (Unit: mm)

2.1.2 Installation

The BM300 should be mounted on the switchgear panel.

- Panel opening dimensions shown in figure 2.1.2.1:

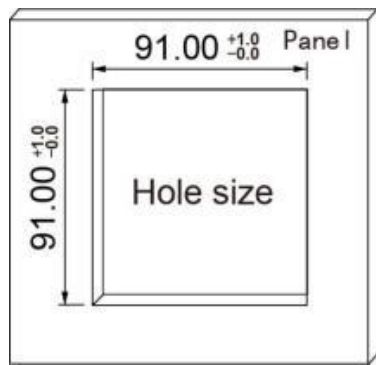

Fig 2.1.2.1 Slots on the panel (unit: mm)

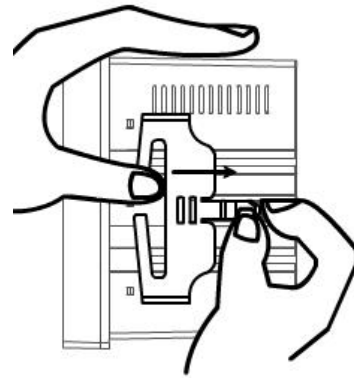

Fig 2.1.2.2 Card is removed

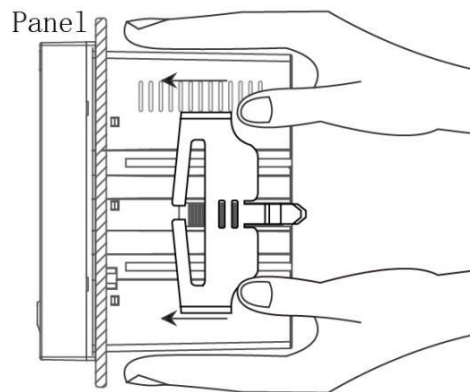

Fig 2.1.2.3 Fixed on the panel by the mounting blocks

- Taking into account the length of wire, the rear panel must be 100mm depth for accommodating IM300. Actual installation, it normally takes the rear there is some space (at least $130 \times 130 \times 100\text{mm}$), ease of installation and wiring.
- Take off the installation card on both sides of the device, as shown in figure 2.1.2.2, with the thumb and forefinger of one hand the fixed head gently lift (lift force is not too large, otherwise it may cause the fixed head fracture), the thumb of the other hand in the direction of the arrow shown in FIG by pushing the catches can be removed. When installing the device on the front panel push into the mounting hole, then from the trench along the rear of the device will be installed on clip. As shown in figure 2.1.2.3, his hands were holding down the top and bottom sides of the device, the top two in the thumb of the clip ends, even before the direction of the arrow to push hard to make catches squeezing panel. After the installation of two cards are installed, the device will be firmly fixed on the panel.

2.1.3 Safety Warnings

- 警告！只能由专业电工进行安装。
- Warning! Installation by person with electrotechnical expertise only.
- Warnung! Installation nur durch elektrotechnische Fachkraft.
- Avvertenza! Fare installare solo da un elettricista qualificato.
- Avertissement! Installation uniquement par des personnes qualifiées en électrotechnique.
- ¡Advertencia! La instalación debe ser realizada únicamente por electricistas especializados.

www.abb.com/lowvoltage/directives

2.1.4 Installation Notes

- Inside of the product is no user-adjustable components, do not open during installation.
- Installation with power on is not allowed.
- Run should meet the ambient temperature $-25\text{ }^{\circ}\text{C} \sim +70\text{ }^{\circ}\text{C}$, humidity 0 to 95%, atmospheric pressure $70\text{kPa} \sim 106\text{kPa}$. Avoid placing the device into strong source of interference, radiation, heat sources and dusty environment.

2.2 Wiring and Configuration

2.2.1 Terminal Definition

BM300 back of a total of two sets of terminals, terminal diagram shown in figure 2.2.1:

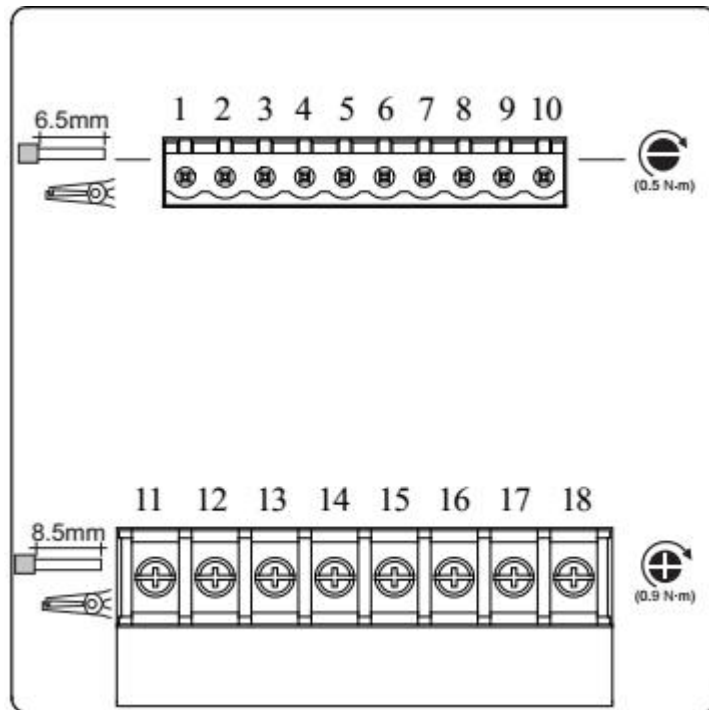

Fig 2.2.1. Terminals figure (back view)

The definition of the terminals shown in table:

No.	1	2	3	4	5	6	7	8	9	10
Definition	PE	L	N	U1	U2	U3	Un	SHIELD	RS+	RS-
	Power Supply			Voltage Inputs				Communication		
No.	11	12	13	14	15	16	17	18		
Definition	I11	I12	I21	I22	I31	I32	NC	NC		
	Current Inputs							Empty terminal		

Note: In the three phase four wire system, the Un is connected to the voltage public end; in the three phase three wire system, the Un is connected to the B-phase voltage.

2.2.2 Power supply wiring

The power supply range of the BM300 is 85VAC ~ 265VAC or 85VDC ~ 265VDC. It can be powered by independent power supply and can also be obtained from the circuit under test. The wiring is as shown in figure 2.2.2.

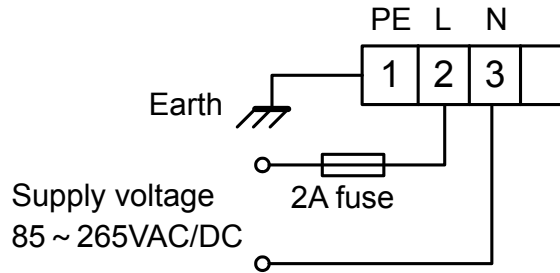

Fig 2.2.2. Power wiring diagram

2.2.3 Electric wiring

- Three phase four wire system: 3CT

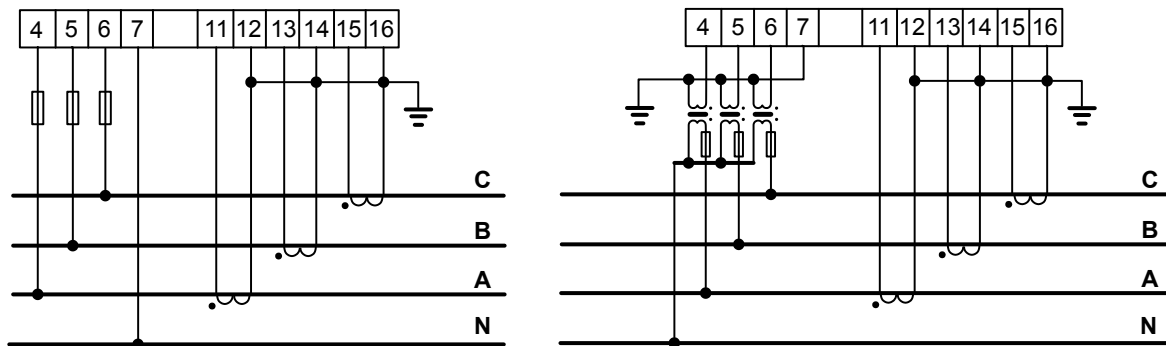

Fig 2.2.3.1 3P4W+3CT

- Three phase four wire system: 1CT

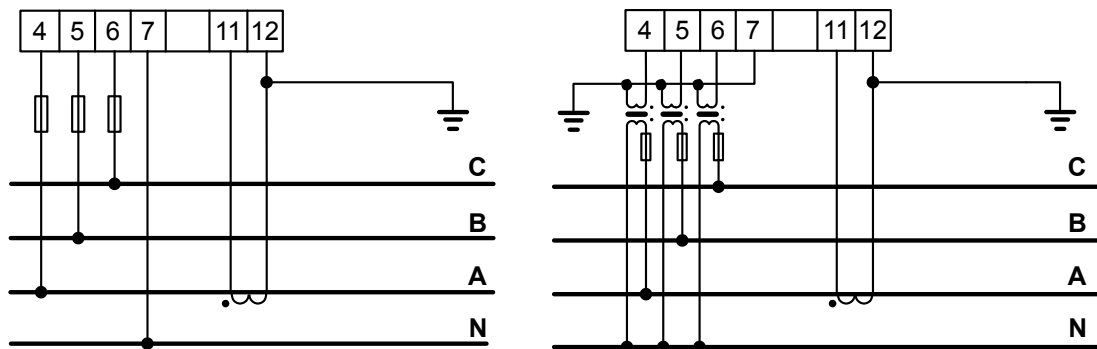

Fig 2.2.3.2 3P4W+1CT

● **Three phase three wire system: 3CT**

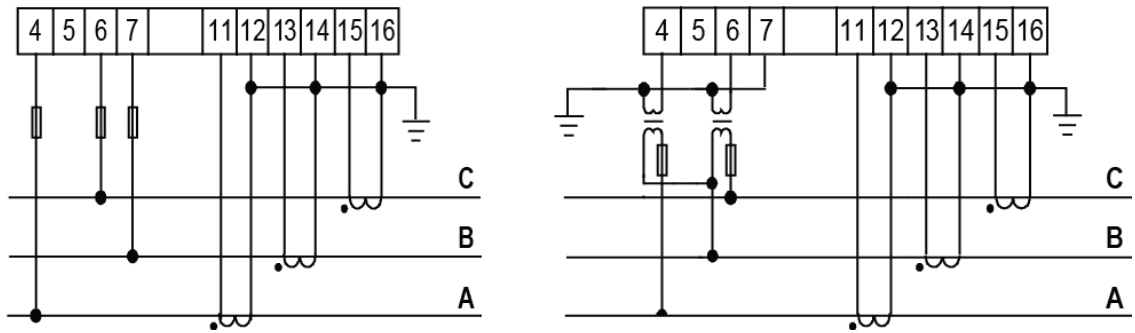

Fig2.2.3.3 3P3W+3CT

● **Three phase three wire system: 2CT**

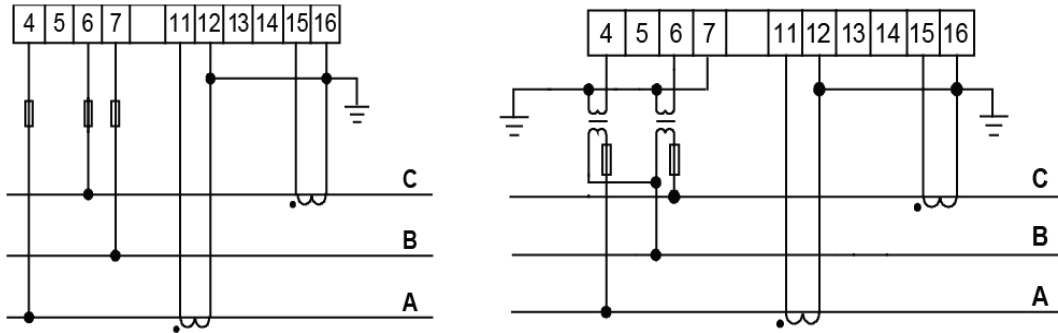

Fig 2.2.3.4 3P3W/3PT+2CT

● **Three phase three wire system: 1CT**

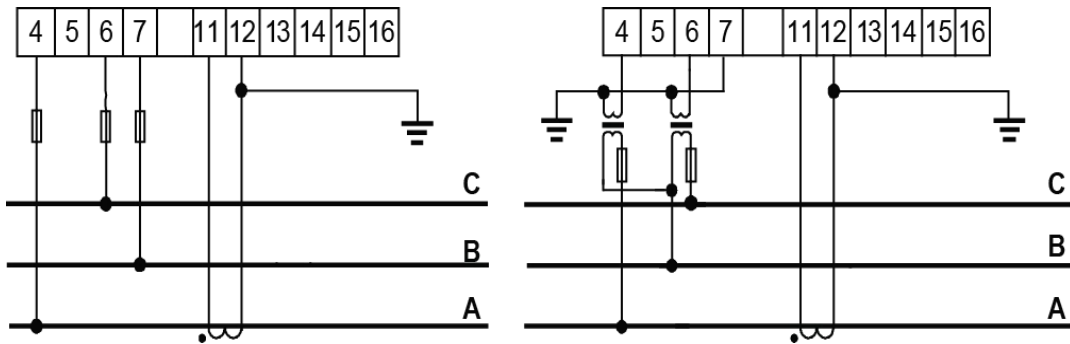

Fig 2.2.3.5 3P3W+1CT

2.2.4 Communication wiring

- **Straight-line Wiring Method:**

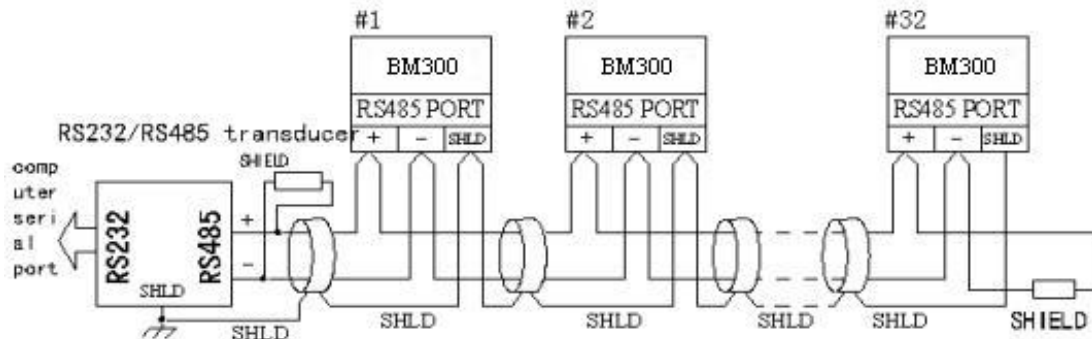

Figure 2.2.4.1 RS485 straight-line wiring method

2.2.5 Wiring Precautions

- The conductor cross section of the connecting wire to the device should meet the following requirements: the cross section of current wires is not less than 2.5 mm², the cross section of voltage wires is not less than 1.0 mm².
- Communication lines must be shielded twisted pair, communication line RS485 +, RS485- can not be reversed.
- The wires of power supply and voltage input must be connected with 2A fuse in series.
- To reduce the impact of current at startup, it is recommended each power cord does not exceed 40 devices.
- When the communication connection using the linear connection, respectively access line should match 100 ~ 120Ω resistor is located between the beginning and end of the communication cable at the RS485 + and RS485- terminals.
- Baud rate is 9600bps, the cable length <1200 meters.

3 Operating Instructions

This chapter details the man-machine interface of the BM300, including how to read data, set related parameters, and soft reset operations.

3.1 button operation





Fig 3.1.1 button

Note: The leftmost button  is an invalid button.



BM300 operation is divided into single button mode and combination button mode two.

Single button mode operates on only one of the four buttons to complete the display of all monitoring data of the device:

- Single button  - Measurement data display: display voltage, current, power factor, power, frequency and other measurement data.
- Single button  - System state display: display system time, communication state, self-check state, version number, etc.
- Single button  -energy shows: display active energy, reactive energy , and so on.

The combination button mode refers to the operation of the button  and the button :

Combination mode entry and exit introduction:

In the single button display mode, just press the button  and button  at the same time, and then loosen it, you can enter the function of the combination button. use the combinatorial button again, you can exit to the single button display mode.

3.2 Data read

The k below the screen indicates that the current display value is 1000 times larger, and the M indicates that the current display value is 1000000 times larger.

3.2.1 Display of measurement data

In the single button mode, press “

Screen 1: Display the three phase current, unit: A.

As shown in the right picture:

$I_a=5.000A$; $I_b=5.001A$; $I_c=5.002A$

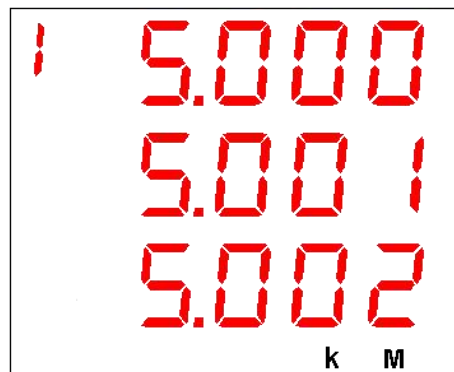

Fig 3.2.1.1 Three phase current

Screen 2: Display the phase voltage, unit: V.

As shown in the right picture, the upper left corner shows the U phase voltage.

From top to bottom, it is shown in turn:

$U_{an}=220.9 V$; $U_{bn}=221.0V$; $U_{cn}=220.3V$

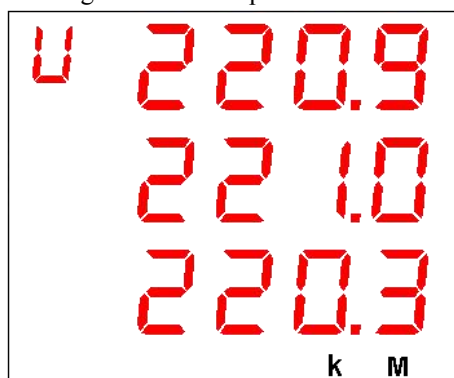

Fig. 3.2.1.2 Phase voltage of three phase

Note: Only when the wiring mode is 3- phase four wire system, this page is displayed. otherwise this page is not display.

Screen 3: Display line voltage unit: V.

As shown in the right, the upper left corner shows the line voltage.

From top to bottom, it is shown in turn:

$U_{ab}=381.7 V$; $U_{bc}=382.1V$; $U_{ca}=380.6V$

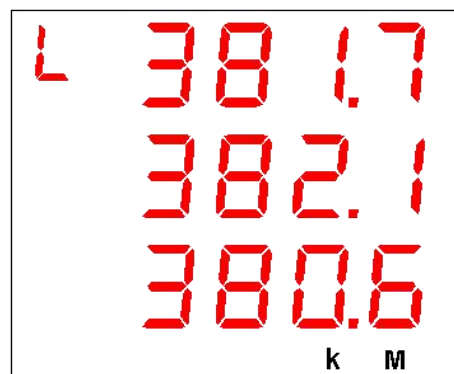

Fig. 3.2.1.3 Line voltage of three phase

Screen 4: Display the total power factor.

As shown in the right: the upper left corner shows λ means power factor $PF = -0.866$

The sign of PF power factor follows the IEC symbol

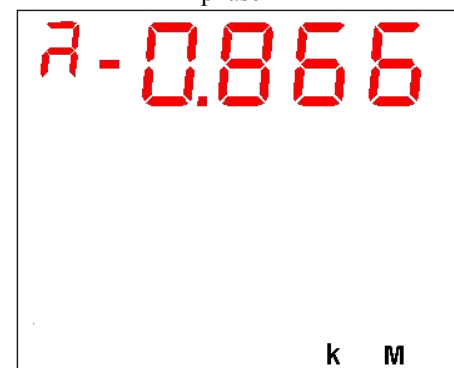

Fig.3.2.1.4 Total power factor

convention

Screen 5: Display three phase power factor.

As shown in the right: the upper left corner shows λ means power factor.

From top to bottom in order:

PFa=-0.866; PFb=-0.867; PFc=-0.868

The sign of PF power factor follows the IEC symbol

convention

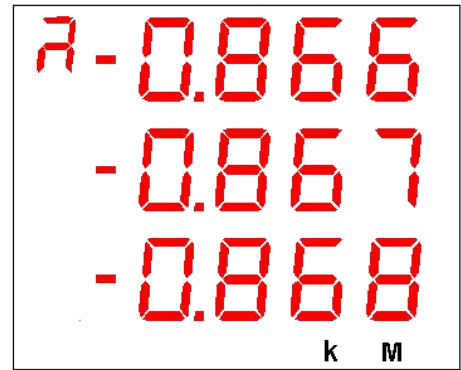

Fig. 3.2.1.5 Three phase power factor

Note: This page is displayed only when the wiring method is three phase four wire system. Otherwise this page does not show.

Screen 6: Display the total active, unit: W.

As shown in the right: The upper left corner of the display P means active.

The k indicator at the bottom right of the screen indicates that the unit is expanded 1000 times.

P=-2.862 kW



Fig. 3.2.1.6 Total active

Screen 7: Display three phase active, unit: W.

As shown in the right: The upper left corner of the display P means active.

The k indicator at the bottom right of the screen indicates that the unit is expanded 1000 times.

From top to bottom in order:

Pa=-0.952 kW; Pb=-0.954 kW; Pc=-0.956 kW

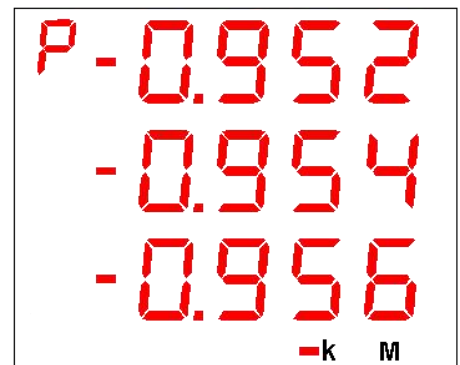

Fig. 3.2.1.7 Three phase active

Note: This page is displayed only when the wiring method is three phase four wire system. Otherwise this page does not show.

Screen 8: Display the total reactive power, unit: var.

As shown in the right: The top left corner shows q means reactive power.

The k indicator at the bottom right of the screen indicates that the unit is expanded 1000 times.

$$Q=1.662 \text{ kvar}$$

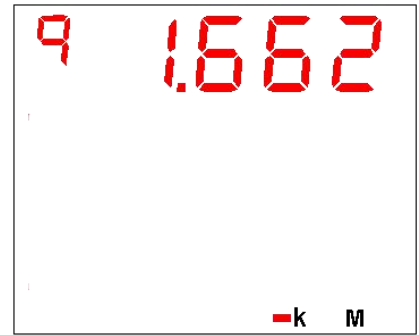

Fig. 3.2.1.8 Total reactive

Screen9: Display 3 phase reactive power, unit: var.

As shown in the right: The top left corner shows q means reactive power.

The k indicator at the bottom right of the screen indicates that the unit is expanded 1000 times.

From top to bottom in order:

$$Q_a=0.553 \text{ kvar}; Q_b=0.554 \text{ kvar}; Q_c=0.554 \text{ kvar}$$

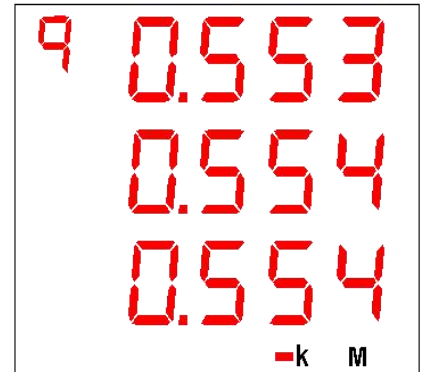

Fig. 3.2.1.9 Three phase reactive power

Note: This page is displayed only when the wiring method is three phase four wire system. Otherwise this page does not show.

Screen 10: Display the total apparent power, unit: VA.

As shown in the right: The upper left corner shows S means apparent power.

The k indicator at the bottom right of the screen indicates that the unit is expanded 1000 times.

$$S=3.321 \text{ kVA}$$



Fig. 3.2.1.10 Total apparent

Screen 11: Display three phase apparent power, unit: VA.

As shown in the right: The upper left corner shows S means apparent power.

The k indicator at the bottom right of the screen indicates that the unit is expanded 1000 times.

From top to bottom in order:

$$S_a=1.106 \text{ kVA}; S_b=1.107 \text{ kVA}; S_c=1.108 \text{ kVA}$$

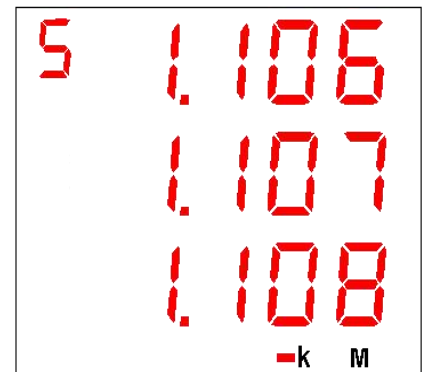

Fig.3.2.1.11 Three phase apparent power

Note: This page is displayed only when the wiring method is three phase four wire system. Otherwise this page does not show.

Screen 12: Display frequency, units: Hz.

As shown in the right: The upper left corner shows F frequency.

$$F=50.00\text{Hz}$$

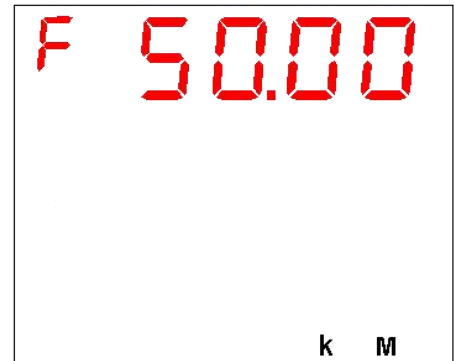



Fig. 3.2.1.12 Frequency

3.2.2 Display energy

In the single button mode, press “” to display the measuring electric data. Each time you press  button scrolls down one screen, to the last screen automatically return to the first screen.

Screen1: Display the absolute value of total active energy

The top left corner of the screen shows E for energy,

The first row shows that P-t means total active.

As shown in the right, $E_p = 3107110.8 \text{ kWh}$.

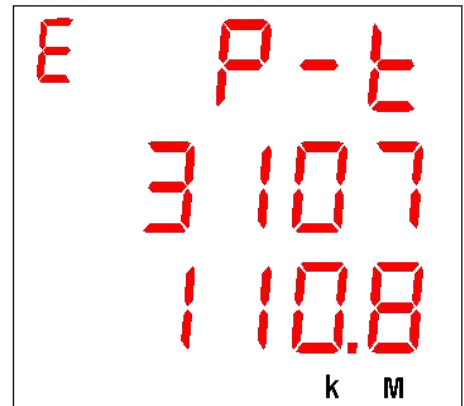

Fig. 3.2.2.1 The absolute value of total active energy

Screen2: Display the absolute value of total reactive energy

The top left corner of the screen shows E for energy,

The first row shows that q-t means total reactive.

As shown in the right, $E_q = 67348.1 \text{ kvarh}$.

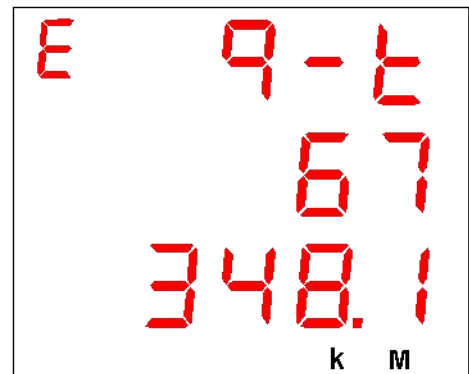

Fig. 3.2.2.2 The absolute value of total reactive energy

Screen3: Display the absolute value of total phase A active energy

The top left corner of the screen shows E for energy,
 The first row shows that P-A means active of A phase.
 As shown in the right, $E_{p-a} = 382190.4 \text{ kWh}$.

Note: This page is displayed only when the wiring method is three phase four wire system. Otherwise this page does not show.

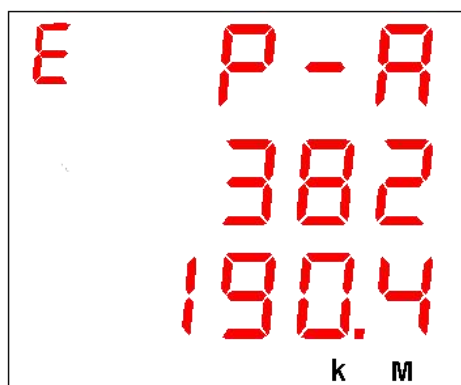

Fig. 3.2.2.3 The absolute value of total phase A active energy

Screen4: Display the absolute value of total phase B active energy

The top left corner of the screen shows E for energy,
 The first row shows that P-B means active of B phase.
 As shown in the right, $E_{p-b} = 362151.1 \text{ kWh}$.

Note: This page is displayed only when the wiring method is three phase four wire system. Otherwise this page does not show.

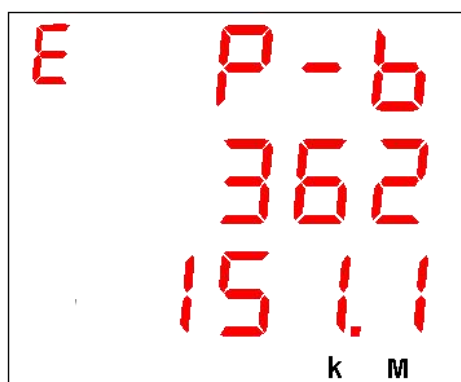

Fig. 3.2.2.4 The absolute value of total phase B active energy

Screen5: Display the absolute value of total phase C active energy

The top left corner of the screen shows E for energy,
 The first row shows that P-C means active of C phase.
 As shown in the right, $E_{p-C} = 1102137.1 \text{ kWh}$.

Note: This page is displayed only when the wiring method is three phase four wire system. Otherwise this page does not show.

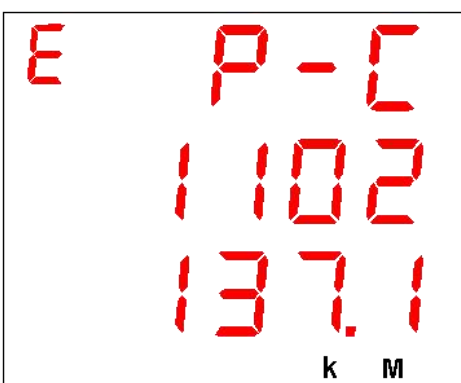



Fig. 3.2.2.5 The absolute value of total phase C active energy

Screen6~Screen8: The sixth screen to the eighth screen: in the three phase four wire system, the reactive absolute value energy of phase A, B and C is shown respectively. The display is basically the same as the third screen and the fifth screen, which can be

read in reference.

3.2.3 Display system status.

In the single button mode, press “ button to scrolls down the screen, to the last screen automatically return to the first screen

Screen1: Display system time

As shown in the right: At 11:28 on June 16, 2008.



Fig. 3.2.3.1 System time.

Screen2: Display communications and self-test status

As shown: the first row of the screen shows "rd", means the data communications received normal, if it is not displayed, the data received is abnormal; the second row of the screen display "td", means the date communications send normal,if it is not displayed, the data received is abnormal, The third row shows the three 0 under normal conditions, when 1 appears, means device exception, need maintenance.

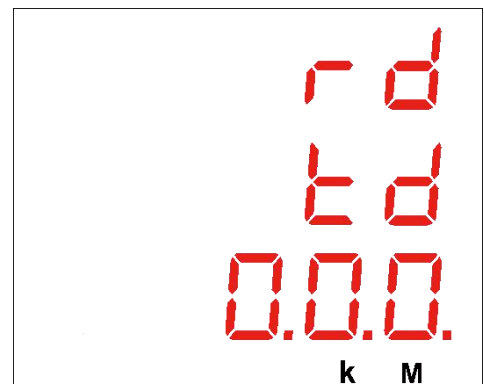

Fig. 3.2.3.2 Communication and self-check status.

Screen3: Display version number

As shown:

"H 1.0", said the hardware version number is 1.0,

"S 1.0", said the software version number is 1.0.

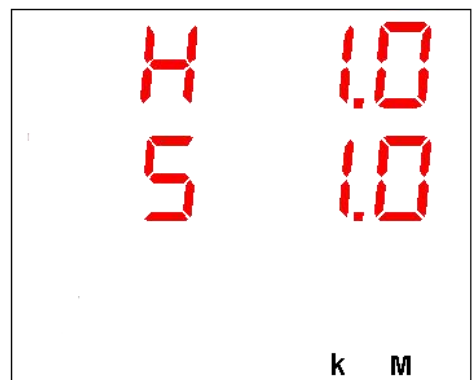











Fig. 3.2.3.3 Version number.

In the single button mode, you can enter the parameter setup mode by pressing “

15

3.3.1 Button function in parameter setup mode

-  button used to activate the current settings page, and cursor position will be flashing shows at the same time, each time you press the  button once to move the cursor one bit left .
-  button is the plus 1 , the flash bit will plus 1 when you press “” once.
- The  button is the parameter confirmation button. When the setting of a screen parameter is completed, press the  button to confirm the parameter. At this time, the words "Y--N" are displayed on the top of the screen, and the choice of Y or N is made according to the  button. When Y is selected, press , and the parameters set are stored and effective. Press  when selecting N, and the parameters currently set are not stored.

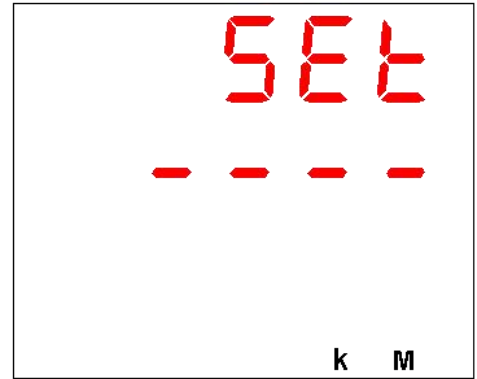





Fig.3.3.2.1 Protection password inquiry page

3.3.2 Introduction of parameter settings

The starting interface of the parameter setting mode is password confirmation. Each time you enter the parameter setting mode, you are prompted to enter the password, and the password is displayed as "--", as shown in the right. The total password is 4 bits, ranging from 0000 to 9999, and the default value of the factory is 0000. According to the  button, you can switch between the 4 cipher bits, add operation according to , range 0~9, and confirm by  button after the input is completed. The parameters can be set only after the password is confirmed, otherwise it will stay on this page.

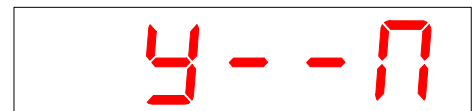

Fig. 3.3.2.2 Is stored tips

Note: This password is different from the password entered in the local operation. See the sixth screen protection password settings for the 3.3.2 section.











When entering the parameter setting screen, such as the current page parameter setting is completed, press the top  button will be prompted Whether to save the current screen to set the parameters , as shown in the right. "Y" represents YES,



Fig.3.3.2.3 Parameter error

which stores the set parameters, and "N" represents NO, that is, it does not store parameters. Press the  button to make the choice of "Y" or "N", and press the  button.

If you select "Y" and press the  button to confirm, if the parameter set are legal, the current parameter is stored. If it is illegal, the word "ERR" is displayed on the top of the screen. As shown in the right picture, the parameters are not stored. At this time, the parameters can be reset according to the  button, and the screen can be scroll press the  button.

Note: No matter which screen parameter setting page, press the  button and the  button will exit the parameter setting mode returns single button display mode, the current page content is not stored; if there is no press  to activate the current settings page, press the  button will directly scroll screen, parameters in current page will not be stored. If there is no button operation in 4 minutes, the screen will automatically return to the single button display mode.

Screen 1: Communication parameters settings

This page is used to set up BM300's communication address, baud rate, and transmission format. The first row of the screen displays the word "CONN", indicating that the current page is a communication parameter setting page.

The second row of the screen displays the communication address, and the range is **1~254**.

The third row of the screen shows the baud rate on the right side, with a range of **0~4**, representing **1.2k, 2.4k, 4.8k, 9.6K, and 19.2kbps**, respectively.

The third row of the most left of the screen is transmission formats, range **0~3**, representing **no parity two bit stop bit, odd check, even check and no parity one bit stop**.

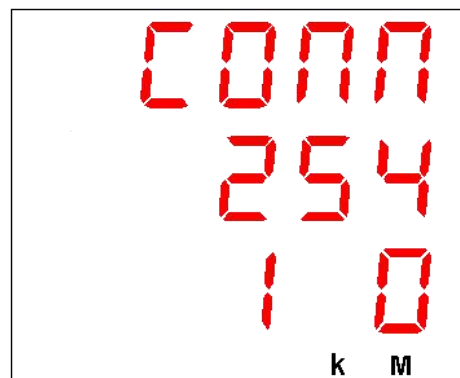

Fig.3.3.2.4 Communication parameter settings page

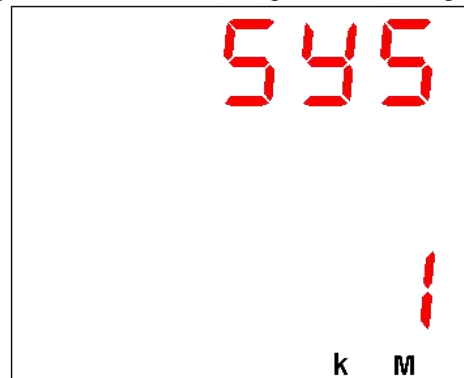

Fig.3.3.2.5 Wiring system settings page

Screen 2: Wiring system settings

This page is used to set the system wiring. The first row row of the screen displays the word "SYS", indicating that the current page sets the page for the system wring setup page .

The screen third row display the number as the wiring modes code, its range 1~5, respectively represents:

- 1: 3P4L 3PT 3CT
- 2: 3P4L 3PT 1CT
- 3: 3P3L 3PT 3CT
- 4: 3P3L 3PT 2CT
- 5: 3P3L 3PT 1CT

Screen 3: PT settings

This page is used to set the PT primary side and the secondary side rated voltage value of PT. The first row of the screen displays the word "PT", indicating that the current page is the PT setting page.

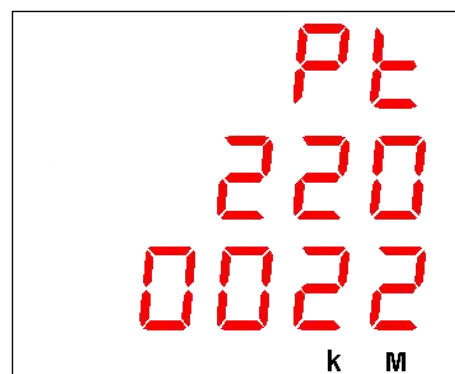

Fig.3.3.2.6 PT settings page

The second row shows the secondary side rating of PT, range from 100V to 220V. The third row shows the primary side rating of PT, range from 100V to 35000V.

Note: The primary side rating on the screen is 10 times smaller than the actual value.

The "0022", as shown on the right, is actually 220V.

Screen 4: CT settings

This page is used to set the primary and secondary rated current value of CT. The first row shows the screen word "CT", means the current page settings for CT. The second row is secondary side rated current value of CT, can only be 1A or 5A.

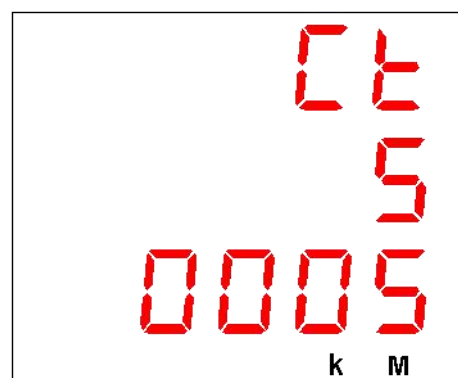

Fig. 3.3.2.7 CT settings page

Note: The primary side of the rated current value can not be less than the rated current value of the secondary side.

Screen 5: System time settings

This page is used to set up system time.

As shown in the figure in the right, it is at 17:30 on August 5, 2008.

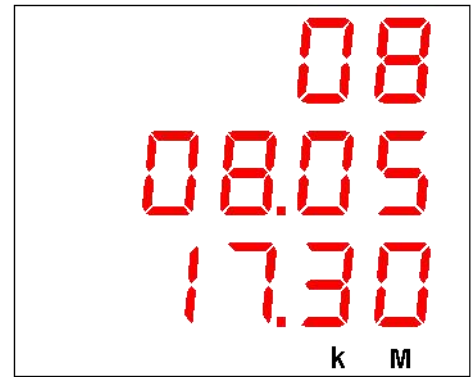

Fig. 3.3.2.8 System time setting page

Screen 6: Password protection settings

This page is used to set the protection password. The first row of the screen displays the word "PASS", indicating that the current page is protected by the password settings page.

A total of two sets of passwords can be set up, such as the right picture, the second row of the screen displays the parameter setting password (the password is entered when the parameter is set), and the third row of the screen shows the operation password, the range is 0000 to 9999.

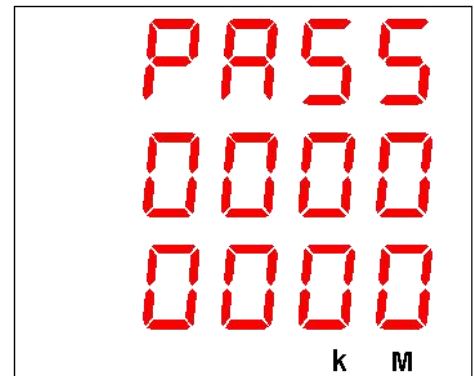

Fig. 3.3.2.9 Password protection settings page

Screen 7: Setting the base value of total active energy

This page is used to setting the base value of total active energy. The first row of the screen shows "EP-T", which is represented as the total active energy.

As shown in the figure in the right, the second and third rows of the screen make up a number "00077888", representing 77888kWh.

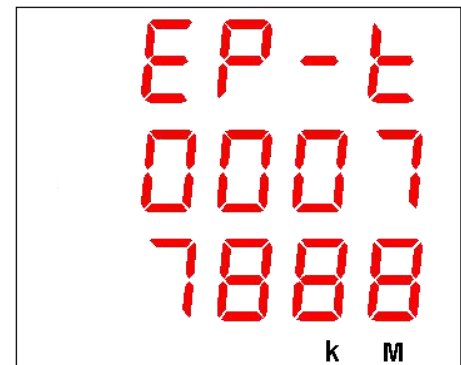

Fig.3.2.10 Setting the base value of total active energy

Note: This page is displayed only when the wiring method is three phase three wire system. Otherwise this page does not show.

Screen 8: Setting the base value of total reactive energy

This page is used to setting the base value of total reactive energy. The first row of the screen shows "Eq-T",

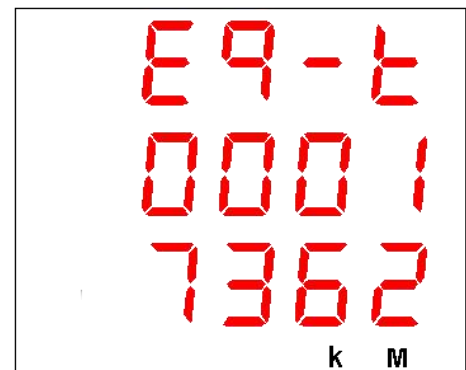

Fig.3.2.11 Setting the base value of total reactive energy

which is represented as the total reactive energy.

On the right, the second and third rows of the screen form a number "00017362", which means 17362kvarh.

Note: This page is displayed only when the wiring method is three phase three wire system. Otherwise this page does not show.

Screen 9: Setting the base value of total phase A active energy

This page is used to setting the base value of total phase A active energy. The first row of the screen shows "ep-a", which represents the active energy of A.

As shown on the right, the second and third rows of the screen form a number "00001152", indicating 1152kWh.





Fig.3.2.12 Setting the base value of total phase A active energy





Note: This page is displayed only when the wiring method is three phase four wire system. Otherwise this page does not show.

Screen 10 ~ 15 : Set up the base separately of B ,C phase active energy,the base of A,B,C phase reactive energy.These pages are only displayed when the wiring method is three phase four wire system.

After all the parameters are set, the  button will be returned to the first screen of the parameter setting.

3.4 Local operation

In the single button display mode, press the  button and  button, enter the parameter setting password input interface, and the first row of the screen displays the word "SET"; At this point, the  button can be switched to the local operation password input interface, and the first row of the screen shows "OPR".

Note: In the local operation mode or parameter setting mode, press the  and  buttons to return the single button display mode directly. The operation in the current page is not implemented; If the current operation page is not activated by pressing the  button, press the  button to turn the screen directly. If there is no button in 4 minutes, it will

automatically return to the single button display mode.

3.4.1 Functions of local operation mode

The functions in local operation mode:

- Clear the cumulative value of energy;
- System reset operation.

3.4.2 Introduction of local operation mode

Starting interface for the local operation mode is password confirmation. Each time you enter the local operation mode, you are prompted to enter the password first, and the password

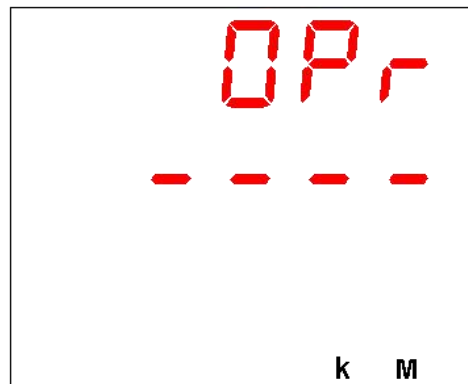



Fig.3.4.2.1 Protect the password inquiry page.

is displayed as "----", as shown on the right. A total of 4 passwords, the range of 0000 ~ 9999, the factory default value is "0000". For increased confidentiality, only digits of the password you are setting are displayed, and all others are displayed as "-". After the completion of the input, press the  button to confirm, if you enter the correct password, enter the first screen of local operation, otherwise stay in this page.

Note: The password entered by the password and parameter setting is different. For details, see section 3.3.2 ,Screen 6 protection password settings page.

Screen 1: Clear the accumulated value of energy

This page is used to clear the accumulated value of energy. Including the total active energy, total reactive energy and the active,reactive energy of each phase. On the right, the first row of the screen shows CLEAR, and the second row shows the words "ENERGY".

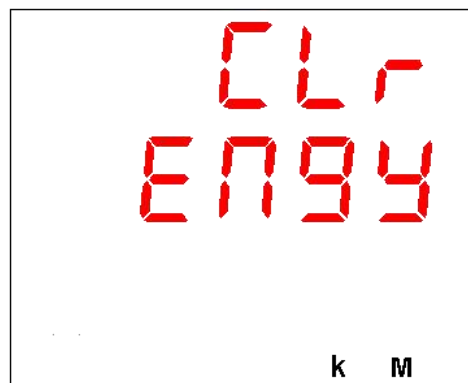

Fig.3.4.2.2 Clear the accumulated value of energy

Screen 2: System reset

This page is used for soft reset of equipment. After this operation, the device is restarted. The first row of the screen shows "RST" means reset, and the second row of the screen displays the word "SYS", means system

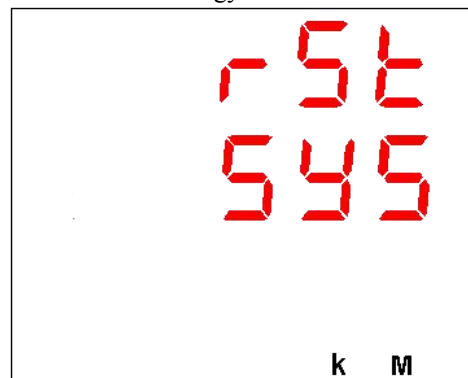

Fig.3.4.2.3 System reset.

4 Communication

4.1 MODBUS protocol overview

MODBUS-RTU communication protocol is more commonly used as a communication protocol, the response from the main station and the slave station connection (half duplex). The main station (for example PC) send a command to all the terminal devices (for example BM300), The addressed terminal device sends a response signal to the host.

4.2 Communication protocol address table and description

4.2.1 Communication protocol address table

System time support for the corresponding No. 3,4,16 function code

Address	Type	Name	Remark	Register
40020	RW	System time××year××month	Only support 3, 4 function code all read, 16 function code all write and broadcast all write	1
40021	RW	System time××day××hour		1
40022	RW	System time××minute××second		1
40023	RW	System time××millisecond		1
40050	RO	Sub-station status		1

System inherent information, parameter support for the corresponding 3,6,16 function code

Address	Type	Name	Remark	Register
40010	RO	ASCII code indicates the hardware version number	Only support write and read continuously	1
40011	RO	ASCII code indicates the software version number		1
40012	RO	ASCII code indicates year		1
40013~40015	RO	ASCII code indicates the product sequence number		3
40055	WO	Sub-station setting		1
40070	RW	Telemetry wiring method	1~5	1
40072	RW	PT primary voltage rating	100~35000V	Only support

40073	RW	PT secondary voltage rating	100~220V	write and read continuously
40075	RW	bit14-bit0 represents CT primary current rating bit15 = 0/1 indicates the secondary is 5A/1A	1~5000A	1

Basic real-time measurement, support 3 compatible with the 4 function code reading rules

Address	Type	Name	Register
40100	RO	Line voltage Uab	1
40101	RO	Line voltage Ubc	1
40102	RO	Line voltage Uca	1
40103	RO	Retain	1
40104	RO	Phase voltage Uan	1
40105	RO	Phase voltage Ubn	1
40106	RO	Phase voltage Ucn	1
40107	RO	Retain	1
40108	RO	Current Ia	1
40109	RO	Current Ib	1
40110	RO	Current Ic	1
40111	RO	Retain	1
40112	RO	Retain	1
40113	RO	Frequency (F)	1
40115	RO	Total power factor (PF)	1
40116	RO	Total active (W)	1
40117	RO	Total reactive power (Q)	1
40118	RO	Total apparent power (S)	1
40119	RO	A Phase power factor (PFa)	1
40120	RO	B phase power factor (PFb)	1
40121	RO	C phase power factor (PFc)	1
40122	RO	A phase active (Wa)	1
40123	RO	B phase active (Wb)	1

40124	RO	C phase active (Wc)	1
40125	RO	A phase reactive power (Qa)	1
40126	RO	B phase reactive power (Qb)	1
40127	RO	C phase reactive power (Qc)	1
40128	RO	A phase apparent power (Sa)	1
40129	RO	B phase apparent power (Sb)	1
40130	RO	C phase apparent power (Sc)	1

Note 1: In the three phase three wire system, the data in 40104 ~ 40107 and 40119 ~ 40130 are invalid and value is 0.

Note 2: The corresponding relation between the above data (Ai) and the actual value is:

Voltage: $U = (A_i/10) \times (PT1/PT2)$, $A_i =$ unsigned integer, unit:V.

Current: $I = (A_i/1000) \times (CT1/CT2)$, $A_i =$ unsigned integer, unit:A.

Active: $P = A_i \times (PT1/PT2) \times (CT1/CT2)$, $A_i =$ has symbolic integer, unit:W.

Reactive power: $Q = A_i \times (PT1/PT2) \times (CT1/CT2)$, $A_i =$ has symbolic integer, unit:Var.

Apparent power: $S = A_i \times (PT1/PT2) \times (CT1/CT2)$, $A_i =$ unsigned integer, unit :VA.

Power factor: $PF = A_i / 1000$, $A_i =$ has symbolic integer, no unit.

Frequency: $F = A_i / 100$, $A_i =$ unsigned integer, unit:Hz.

Energy real time measurement, support 3 function code reading rules and 16 function code base setting rules

Address	Type	Name	Register
40200	RW	The absolute value of total active energy	2
40202	RW	The absolute value of total reactive energy	2
40204	RW	The absolute value of total phase A active energy	2
40206	RW	The absolute value of total phase B active energy	2
40208	RW	The absolute value of total phase C active energy	2
40210	RW	The absolute value of total phase A reactive energy	2
40212	RW	The absolute value of total phase B reactive energy	2
40214	RW	The absolute value of total phase C reactive energy	2

Note 1: In three phase three wire system, address 40200~40202 read and write are valid, read and write 40204 ~ 40214 invalid;

In three phase four wire system, address 40200~40202 is read only, 40204~40214 read and write is valid.

Note 2: The corresponding relation between the above data (Ai) and the actual value is:

Active: $E_p = A_i / 10$, $A_i =$ unsigned long integer (0~999999999), unit:kWh.

Reactive power: $E_q = A_i / 10$, $A_i =$ unsigned long integer (0~999999999), unit:kvarh.

Important data reads the message and supports the 3 and 4 code reading rules (a total of 25 registers only support continuous read).

Address	Type	Name	Register
42000	RO	Telesignalling	1
42001	RO	Retain	1
42002	RO	Current Ia	1
42003	RO	Current Ib	1
42004	RO	Current Ic	1
42005	RO	Retain	1
42006	RO	Line voltage Uab	1
42007	RO	Line voltage Ubc	1
42008	RO	Line voltage Uca	1
42009	RO	Phase voltage Uan (valid in three phase four wire system)	1
42010	RO	Phase voltage Ubn (valid in three phase four wire system)	1
42011	RO	Phase voltage Ucn (valid in three phase four wire system)	1
42012	RO	Frequency (F)	1
42013	RO	Total active (W)	1
42014	RO	Total reactive power (Q)	1
42015	RO	Total apparent power (S)	1
42016	RO	Total power factor (PF)	1
42017	RO	Total active energy (Ep)	2
42019	RO	Total apparent energy (Eq)	2
42021	RO	Retain	2
42023	RO	Retain	2

4.2.2 Explanation of register address

- Hardware version number register (40010): stored in the program memory.
- Software version number register (40011): stored in the program memory.
- Production year (40012): stored in E2PROM.
- Product serial number (40013~40015): stored in E2PROM.
- System time - year, month register (40020): high byte denotes year, range 00~99, denotes 2000~2099; low byte denotes month, range 1~12.
- System time - day, hour register (40021): high byte denotes day, range 1~31; low byte denotes hour, range 00~23.
- System time - minute, second register (40022): high byte denotes minute,, range 00~59; low byte denotes second, range 00~59.
- System time - millisecond register (40023): range 0~999.
- Substation status register (40050):

Address	Definitions	Default value	Remark
Bit0	Retain	0	
Bit1	Retain	0	
Bit2	Retain	0	
Bit3	Sign of checking time	1	Cleared after remote time tick
Bit4	Retain	0	
Bit5	Retain	0	
Bit6	Retain	0	
Bit7	Retain	0	
Bit8	Retain	0	
Bit9	Hard clock anomaly	0	Dynamic
Bit10	Retain	0	
Bit11	Retain	0	
Bit12	E2p reading and writing anomaly	0	Dynamic
Bit13	AD acquisition anomaly	0	Dynamic
Bit14	Retain	0	
Bit15	Retain	0	

● Substation setting register (40055):

Address	Definitions	Default value
Bit0	Retain	0
Bit1	Retain	0
Bit2	Clear all energy	0
Bit3	Retain	0
Bit4	Retain	0
Bit5	Retain	0
Bit6	Retain	0
Bit7	Retain	0
Bit8	Freeze all the energy	0
Bit9	Unfreeze all the energy	0
Bit10	Retain	0
Bit11	Retain	0
Bit12	Retain	0
Bit13	Retain	0
Bit14	Retain	0

Note: The BM300 supports energy broadcast and normal freeze /unfreeze functions. It needn't to return messages when broadcast freeze or unfreeze. After sending the freeze command by the upper computer, all of the reading energy values are equal to the electric accumulated value of the frozen moment, but the internal measurement of energy value continues to accumulate. If you want to refresh the reading total value of energy, the upper computer must sending the unfreeze command. This facilitates the user's unified meter reading.

● Energy freeze and unfreeze status register (40060):

The high byte is 00, BIT1 of low byte denote energy freeze and unfreeze status, other bits are inefficient.

1 denotes freeze and 0 denotes unfreeze.

● Telemetry wiring (40070):

1 to 5 represent three phase four wire 3CT (3P4W / 3PT + 3CT), three phase four wire 1CT (3P4W / 3PT + 1CT), three phase three wire 3CT (3P3W / 3PT + three phase three wire 2CT

(3P3W / 3PT (or 2PT) + 2CT), three phase three wire 1CT (3P4W / 3PT + 1CT).

5 Transportation and storage

When being transported, the product should be packed. Violent vibration and strike must be avoided. The ambient temperature should be between -30°C and $+80^{\circ}\text{C}$ and the relative humidity should be less than 95%. There should be no corrosive gas and mildew in the air.

Appendix

A. The default value

No.	Description	Defaults	Remark
1	COMM: Communication parameter	254, 3, 0	Communication address is 254; Baud rate is 9600bps ; Transmission format: 1 start bit, 8 data bits, no parity check, 2 end bits
2	SYS :System wiring	1	3P4L 3PT 3CT
3	PT1 primary voltage	220	Unit: V
4	PT2 secondary voltage	220	Unit: V
5	CT1 primary current	1000	Unit: A
6	CT2 secondary current	5	Unit: A
7	Parameter setting protection password	0000	
8	Local operation protection password	0000	

B. Technical Indicators

● Standards

GB/T 13729-2002	Remote terminal unit equipment	
GB/T 17626.2-2006	Electrostatic discharge immunity test	Level 3
GB/T 17626.4-2008	Electrical fast transients immunity test	Level 3
GB/T 17626.5-2008	Surge immunity test	Level 3
GB/T 17626.8-2006	Power frequency magnetic field immunity test	Level 3
GB/T 17626.12-1998	Oscillation wave immunity test	Level 3

● Monitor Technical index

Voltage	Precision: 0.5;	Range: 0~42000V
Current	Precision: 0.5;	Range: 0~6000A
Power factor	Precision: 1.0;	Range: $0 \leq \cos\Phi \leq 1$
active	Precision: 1.0;	Range: 0~756000kW
Reactive power	Precision: 1.0;	Range: 0~756000kvar
Inspecting power	Precision: 1.0;	Range: 0~756000kVA
Active energy	Precision: 1.0;	Range: 0~99999999.9 kWh
Reactive energy	Precision: 1.0;	Range: 0~99999999.9 kvar
Frequency	Precision: 0.01Hz;	Range: 45~65Hz

● Working parameters

Power Supply:	Range:85VAC/DC~265VAC/DC
Power consumption:	<5W
Working environment:	-25℃ ~ +70℃, 95% non-condensing
Store temperature:	-30℃ ~ +80℃
Display:	LED digital display
Weight:	300g
Internal protection:	Panel:IP50, shell:IP20

Input characteristics:	Phase voltage rating: 220VAC Range: 20VAC~264VAC Current rating:5A; Range:0.05AAC~6 AAC Current rating:1A; Range:0.01AAC~1.2 AAC Frequency Range: 45 Hz~65Hz
Communication:	Communication interface: RS485 Communication protocol: MODBUS-RTU Communication speed:1200/2400/4800/9600/19200bps
Display refresher rate:	<1s

C. Order instructions

Relevant standards (corresponding to nameplate content) to be marked when ordering

- The power supply standard configuration: AC or DC power supply 85VAC/DC ~ 265VAC/DC, 5W;
- The CT rated the standard input: 5AAC, continuous 2 times overload;

Optional input: 1AAC, continuous 2 times overload.



联系我们

北京ABB低压电器有限公司

地址：北京市大兴区经济技术开发区康定街17号

邮编：100176

客户服务电话：+86 10 58085093

技术支持：+86 10 58085092

传真：+86 10 58085288

Contacts

ABB LV Installation Materials Company Limited

Address: No. 17 Kangding Street, BDA, Beijing,
100176, P.R.China

Customer Service Tel.: +86 10 58085093

Technical Support Tel.: +86 10 58085092

Telefax: +86 10 58085288